

Traditions™

PERFORMANCE FIREARMS

Muzzleloader Owner's Manual

YUKON™

DROP BREECH ACTION
MUZZLELOADER

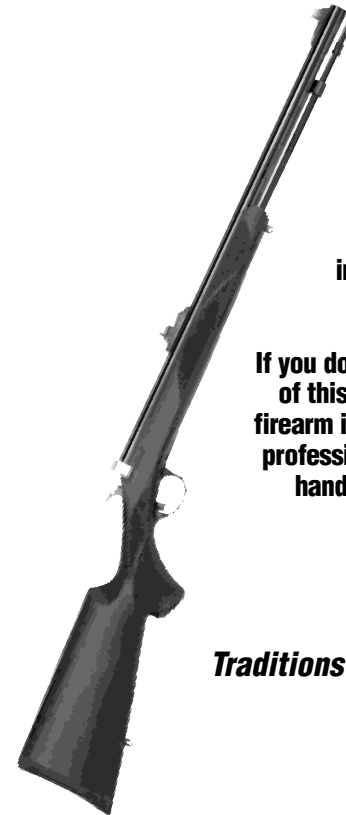

IMPORTANT!

Thoroughly read and understand all of the instructions and warnings in this manual **BEFORE** using your Traditions firearm.

If you do not understand any aspect of this manual seek black powder firearm instruction from a qualified, professional instructor **BEFORE** you handle, load or use this firearm.

Traditions Performance Firearms

1375 Boston Post Road
P.O. Box 776
Old Saybrook, CT 06475

www.traditionsfirearms.com

email: info@traditionsfirearms.com

Traditions™
PERFORMANCE FIREARMS

P.O. Box 776
Old Saybrook, CT 06475-0776

Place
Postage Here.
Or for additional
security enclose
in a envelope.

FOR YOUR RECORDS

Important: Please record information here and keep for your record.

Model No. _____

Serial No. _____

Model Name _____

Caliber _____

Date Purchased _____

From _____

Registration Card mailed on _____

CAUTION: Please read and understand all information in this booklet before using your new Traditions firearm. If all safety information is not read and the WARNING, CAUTION and IMPORTANT statements are not understood, death or injury could result.

Please call Traditions Customer Service Department at 1-800-526-9556 with any questions or concerns.

Traditions™
PERFORMANCE FIREARMS

YOUR MUZZLELOADING RIFLE

Congratulations on your purchase of the new **Traditions YUKON™ Drop-Breech Muzzleloader**. You have selected a muzzleloading firearm designed and engineered to give today's shooters the highest performance and optimum accuracy. When given the respect and care that any firearm demands, you can expect many years of reliable service and enjoyable hunting from your new Traditions muzzleloader.

The new **Traditions YUKON™ Drop-Breech Muzzleloader** is easy to load, shoot and clean. The slide action button is on the side of the receiver for ease in opening. The extended hammer has an ambidextrous spur for left or right hand shooting. You simply need to unscrew the spur and switch it to the appropriate side of the hammer. The solid aluminum ramrod has an extended jag that can be reversed and attached to make the ramrod full length for easy loading and cleaning.

IMPORTANT!

A person using any firearm has elected to take on an enormous responsibility. This manual contains instructions, cautions and dangers for the safe enjoyable use of your Traditions muzzleloader. Shooting a firearm is a serious endeavor. These instructions and precautions should always be followed during each shooting session.

CAUTION:

If you sell, trade or give this rifle to another person, be sure to give the new owner a copy of this manual. Copies of this manual are available free of charge from **Traditions Performance Firearms**. Call 1-800-526-9556, or fax 860-388-4657 or email us at info@traditionsfirearms.com

**TRADITIONS' WARRANTY PROTECTION
INCLUDED WITH YOUR NEW GUN**

Thank you for purchasing the Traditions muzzleloader. Quality, pride and old world craftsmanship has gone into your new Traditions muzzleloader. We work hard to provide the best value and performance possible, we back it up with a limited lifetime warranty. Should you ever experience mechanical difficulty with your new Traditions firearm, be assured that we are staffed and equipped to correct it quickly. Your satisfaction with your firearm is very important to Traditions.

PLEASE HELP US SERVE YOU BETTER

In the unlikely event you need warranty service on your new firearm, we need your help to get the work done right and without delay. It's as easy as dropping us a note or picking up the telephone.

Traditions conveniently engraves the caliber, serial number and model name on each barrel. Take note of this information, record it on the warranty page in this manual and be prepared to state it when contacting the Traditions Customer Service Department with your questions.

Contact Traditions at 1-800-526-9556, tell us what problem you are experiencing and we'll get busy to remedy your situation.

Help is just a phone call away should you experience a problem. Simply follow these four simple steps and we'll get your firearm back in perfect working order in the shortest possible time.

- 1. Do not return your firearm to the dealer. You can save time by following the steps outlined below.**
2. Do call us and describe the problem. Chances are we can either guide you to a solution right over the phone or when possible send you the parts you need to correct the problem.
3. Should your gun need factory service, we will give you instructions about where to ship it and issue you a Return Merchandise Authorization number.
4. We will inspect your firearm and make necessary repairs that are covered under warranty.

Often we can help you by phone, call before you return your Traditions firearm for service. Good Shooting!

1-800-526-9556

Important: All firearms must have a factory issued Return Merchandise Authorization number (RMA#) before returning to Traditions for warranty service.

TABLE OF CONTENTS

I.	THE SPORT OF MUZZLELOADING	1
II.	GENERAL SAFETY RULES	2
III.	MUZZLELOADING MUSTS	12
IV.	WARRANTY	15
V.	MAKING SURE YOUR MUZZLELOADER IS UNLOADED	16
VI.	SAFETIES INCLUDED WITH YOUR MUZZLELOADER	17
VII.	DISASSEMBLY & ASSEMBLY OF MUZZLELOADER	19
VIII.	IGNITION AND BREECH PLUGS	20
IX.	PREPARING TO LOAD AND LOADING A MUZZLELOADING SHOTGUN	22
X.	PRIMING YOUR MUZZLELOADER	25
XI.	DECAPPING AFTER FIRING	27
XII.	HANGFIRES & MISFIRES	28
XIII.	REMOVING THE PROJECTILE (SHOT) AND POWDER CHARGE	28
XIV.	SIGHTING IN AND SCOPE MOUNTING	30
XV.	RECOMMENDED LOADS	31
XVI.	CLEANING AND MAINTENANCE	32
XVII.	HELPFUL MUZZLELOADING ACCESSORIES	38
XVIII.	WARRANTY CARD	39

YUKON Drop-Breech Muzzleloader

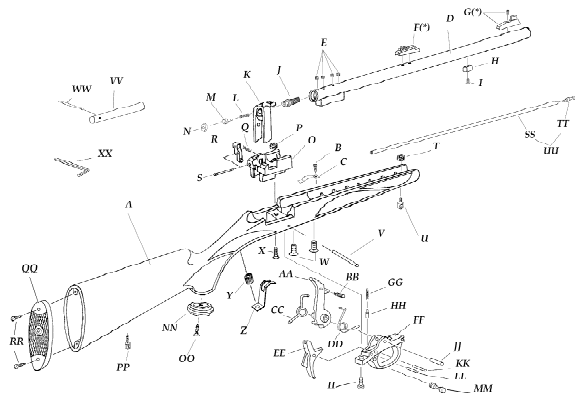

DESCRIPTION

A	Stock (AW Composite) (Finished).....	FGS40101	Y	Stock Insert.....	40606
B	Ramrod Retaining Spring Screw.....	21817	Z	Hammer Guide.....	400029
C	Ramrod Retaining Spring	400030	AA	Hammer.....	4002
D	Barrel Assembly (Kit) (Length 24")		BB	Hammer Handle.....	710004
	.50 cal. perc. (twist 1-28")	C-400034-B	CC	Hammer Mainspring.....	M10018
	Barrel Assembly (Finished) (Length 24")		DD	Hammer Antagonist Spring	M10017
	.50 cal. perc. Blued (twist 1-28").....	FB400034	EE	Trigger	1003
E	Plug Screw (4)	26029	FF	Trigger Guard.....	10027
F	Lite Optic Rear Sight	50610-LU	GG	Trigger Guard Spring	M71015
G	Lite Optic Front Sight.....	50611-LU	HH	Pin	71000
H	Ramrod Thimble	440032-P	II	Trigger Guard Screw	10021
I	Ramrod Thimble Screw.....	400031	JJ	Hammer Pin.....	10031
J	Hexagonal Breech Plug (S/S)	7200099	KK	Trigger Pin	10025
K	Breech Block	40005	LL	Safety Pin	710029
L	Firing Pin Spring	71011	MM	Safety.....	710032
M	Firing Pin	40007	NN	Pistol Grip Cap.....	50104
N	Firing Pin Washer	40016	OO	Pistol grip Cap Screw	50105
O	Frame (Aluminum)(Blued).....	40004	PP	Sling Swivel Stud-Rear	37013
P	Frame nut	60122	QQ	Buttpad	60126
Q	Breech Block Release Spring.....	40012	RR	Buttpad Screw (2)	20634
R	Breech Block Release Button.....	40010	SS	Ramrod 28" (Aluminum).....	M120030
S	Breech Block Release Pin	40014	TT	Ramrod Tip .50 Cal (Aluminum).....	M100028
T	Sling Swivel Stud - Front nut	60122	UU	Ramrod Assembly	120011
U	Sling Swivel Stud - Front	37122	VV	Hexagonal Wrench.....	720029
V	Trigger Guard Pin	40013	WW	Wrench Handle	400033
W	Frame-Barrel Screw (2).....	10060	XX	Allen Wrench	M1005
X	Frame Screw	40012			

YUKON Drop-Breech Muzzleloader

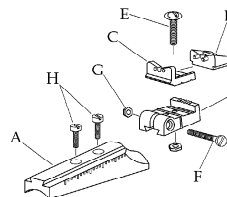

**Lite Optic Rear Sight
Ref. 50610-LU**

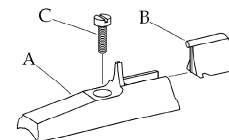

**Lite Optic Front Sight
Ref. 50611-LU**

DESCRIPTION

A	Rear Sight Base (Round).....	50613	A	Front Sight Base (Round)	M50611-LU
B	Elevator Base.....	50614	B	Luminous Insert	36613
C	Rear Sighting Blade	50615-LU	C	Front Sight Mounting Screw.....	50623
D	Luminous Insert	50606			
E	Windage Adjustment Locking Screw.....	50624			
F	Elevation Adjustment Locking Screw	50616			
G	Hex. Nut (2).....	50618			
H	Rear Sight Mounting Screw (2).....	50622			

NOTES



I. THE SPORT OF MUZZLELOADING

More and more sportsmen have discovered the challenges and enjoyment of muzzleloading in the past years. For both hunting and target shooting, muzzleloading guns have helped a modern generation recapture and enjoy an important aspect of our nation's sporting past.

Traditions Muzzleloaders are firearms that represent the latest developments in this unique part of the shooting sports. They are manufactured to modern standards for safe and enjoyable shooting.

This booklet is intended as a basic guide for the proper maintenance, loading and shooting of Traditions muzzleloaders, and it offers important rules and precautions for safe handling and shooting of this type of firearm. In addition to this booklet, it is recommended that the novice obtain further information and instruction before firing a muzzleloader.

Sources for this help include:

1. National Muzzle Loading Rifle Association.
2. National Rifle Association.
3. Your town clerk, local sporting goods dealer, state DEP or conservation department.
4. Contact your local muzzleloader or hunting club.

II. GENERAL SAFETY RULES

WARNING!

This muzzleloader, like other firearms, is potentially a lethal weapon that can cause serious injury, death or damage to property if handled improperly.

Firearms safety is YOUR responsibility!

There is no such thing as a “safe” or “foolproof” firearm, as firearms, by their very nature, are inherently dangerous. Handling your Traditions firearm safely **depends on YOU!** Handled safely, your firearm will give years of shooting enjoyment. Handle it carelessly, and YOU will put yourself and everyone around you in danger of serious injury or death. Safety must be the first, foremost and constant consideration of everyone who handles a firearm. When handling a firearm, you cannot guess, you cannot forget, you cannot allow yourself even a momentary lapse of attention or good judgment, or irreversible tragedy may result.

RULES OF FIREARMS SAFETY

1. Treat all firearms as if they were loaded, at all times. Many accidents occur with firearms that are handled carelessly, because they are believed to be “unloaded”. These accidents can be avoided by handling all firearms the same way you would handle a loaded firearm, at all times. Even after you verify that a gun is unloaded, you should continue handling it as you would a loaded gun, and make sure that others around you do the same.
2. Point the muzzle in a safe direction at all times. A “safe direction” is one in which, if the firearm were to discharge, there would be no injury to anyone. Never point a gun (whether you think it is loaded or unloaded - see Rule #1 above) directly at another person or at yourself. Consider that a bullet can ricochet (glance off) pavement, floors, walls, rocks, the ground, water, ice or almost any other object it strikes. Also, bullets can penetrate walls, ceilings, floors, doors, windows, and many other materials to kill or injure someone on the opposite side.
3. Keep your finger off the trigger and outside the trigger guard until you are aimed at a proper target and have decided to fire. If your finger is inside the trigger guard, you could fire your gun without intending to - for instance, if you were startled, or if you slipped or lost your balance. By keeping your finger outside the trigger guard until you are on target and intend to fire, you ensure that you will never hit anything you do not intend to.

4. Be sure of your target, and what is around and beyond it. The bullet fired from your rifle can travel over one mile, and has the potential to kill or seriously injure someone at that distance! Once you pull the trigger, you cannot call the bullet back, so you must positively identify your target before you fire. Never fire (for instance, at a noise, a movement, a rustling bush, or a shape in the dark) until you have positively identified your target as something you intend to shoot. Fire only with a safe backstop behind your target - something that will stop and contain the bullets you fire, even if you miss the target or your bullet passes through it.
5. Whenever you handle a firearm that, even momentarily, has been out of your direct control, start by checking its condition to determine whether or not it is loaded. A firearm in your hands is a lethal weapon which is YOUR responsibility, so YOU must check it yourself, NOW, not later. Do not rely on someone else to check it. Do not take someone else's word for the firearm's condition. Do not rely on your memory of having checked the firearm previously, or on your belief that you left it unloaded the last time you used or handled it. Check it again yourself now.
6. Never give a firearm to anyone, or take a firearm from anyone, unless it is unloaded and the action is open. If someone tries to hand you a firearm with the action closed, politely ask them to open it before you take it from them. If you need to open the action of a firearm with which you are not

familiar, don't experiment, lest you make a fatal mistake! Instead, ask someone who knows how to handle the firearm to open the action and allow you to verify that it is unloaded. If you can't find someone who knows how to handle the firearm, leave it alone!

7. Firearms should be unloaded when not actually in use. Load your firearm only when you are on the target range or in the field and ready to begin using it. Unload your gun as soon as you are finished shooting. Unload your gun before you bring it back into your car, camp or home. Never leave a loaded gun unattended, even for a moment.
8. Thoroughly read and understand the owner's manual and other literature supplied with your firearm. Never use any firearm unless you completely understand how it operates and how its safety features work. Contact Traditions if you have any questions or concerns, or if you are not certain you have all the literature supplied with the firearm at the time it was first sold. Even if you understand everything in this manual, no manual can provide you with the benefits of hands-on firearms instruction. If you are not already an experienced firearms user, you should obtain training in the safe and proper use of firearms by attending one of the many firearms safety and shooting courses offered in all parts of the country by the National Rifle Association (telephone 703-267-1000), gun clubs and ranges, gun shops, shooting schools and other qualified sources of instruction.

9. Before firing any firearm, be sure it is in good working order and that the barrel is clear of dirt, grease, water, excess oil, rust, corrosion or any other obstruction.
10. Always wear high-quality ear and eye protection when shooting or observing, and be sure that others who are present do the same. Exposure to gunfire noise will cause permanent hearing loss (deafness) if good ear protection (either commercially manufactured ear plugs, earmuff-type hearing protectors, or both) is not worn. Close-fitting, impact-resistant shooting glasses or safety glasses of wraparound or side-panel design help to guard against potentially blinding eye injuries caused by granules of powder, splashback of fragments from the target or backstop, metal fragments which can result from a burst primer, etc. Never shoot a firearm, or allow yourself or others to be present where shooting is in progress, without both eye and ear protection in place. Eye protection can also provide important protection while you are disassembling and cleaning your firearms, both from flying firearms parts, and from aerosols and other solvents and cleaning fluids that can spray or splash into your eyes, causing serious eye injury.
11. Firearms, drugs and alcohol don't mix! Never handle firearms while under the influence of alcohol or drugs (including prescription medications) that can impair your normal senses, abilities, alertness, reflexes, perception or judgment. Make sure everyone in your presence follows the same rule. Also, avoid handling

firearms when you are ill, exhausted, upset or preoccupied with other concerns - safe firearms handling requires your full attention, and all of your abilities, unimpaired by other factors.

12. Any firearm which is not under your direct control should be stored so it is inoperable or inaccessible to children and other unauthorized users. Children are attracted to, and can find, load and operate firearms, causing serious injury or death to themselves and others. Preventing child access and tragic, avoidable accidents is **YOUR** responsibility, as an adult gun owner. The safest way to store firearms is unloaded, locked in a gun safe or vault.

SAFETY RULES AND PRECAUTIONS
FOR FIRING AND USE OF YOUR
TRADITIONS FIREARM

WARNING!

Keep the safety engaged in the “Safe” position until you are aimed at a proper target and have decided to fire. Failure to do so could cause serious injury or death.

WARNING!

Use the safety on this rifle, but don't trust or rely on it as a substitute for safe gun handling practices. The safety is a mechanical device which could fail. Or, by mistake, you may think the safety is on when it is not. Or the safety may become disengaged without your knowledge. Or you could think your gun is unloaded when it is loaded. Always follow the safe gun handling rules and procedures in this manual, whether you think the safety is on or off, and whether you think the rifle is loaded or unloaded. Don't pull the trigger when the safety is engaged, or when it is positioned part way between Safe and Fire. Don't use or rely on the safety lever to try to “childproof” your rifle or keep it safe from untrained persons - instead, your rifle should be unloaded and securely locked up, out of access of children and other unauthorized users.

WARNING!

Keep your finger off the trigger and outside the trigger guard until you are aimed at a proper target and have decided to fire. Failure to do so could cause serious injury or death.

WARNING!

Keep hands, fingers and other body parts from touching the muzzle, barrel or chamber after firing, as they could be burned by hot metal.

WARNING!

If dropped or struck, whether the safety is “on” or “off”, the rifle may fire, causing serious injury or death. Keep the rifle unprimed (without a 209 primer in the breech) unless actually firing! Keep the safety “on” unless actually firing! When carrying or handling the rifle, keep it pointed in a safe direction, and carry it in such a way that you can safely control the direction in which the rifle points even if you should slip, stumble or fall.

WARNING!

Children are attracted to, and can find, load and operate firearms, causing serious injury or death to themselves and others. Prevent child access by always keeping guns locked away and unloaded when not in use. If you leave a gun loaded or unloaded where a child obtains and improperly uses it, you may be fined or sent to prison or both.

Never transport or carry a loaded firearm in a vehicle or otherwise. Always transport or carry your rifle unloaded, with the safety engaged and the action

open. A suitable carrying case should be used to transport or carry your unloaded rifle to and from the range or other safe shooting area. Check the laws to determine and follow legal requirements in transporting a firearm in your jurisdiction. Close the rifle's action and load the rifle only when you are at the range or other safe shooting area, ready to begin shooting.

Never climb a fence, ladder, tree or other object, jump across a brook or ditch, crawl under a fence or other obstacle, walk across an icy surface, steep slope or other area with poor footing, or cross other slippery or precarious terrain or obstacles with a loaded firearm. Instead, un-prime your firearm first. When carrying your rifle in the field, keep the muzzle pointed in a safe direction and carry the rifle so you can safely control the direction in which it points in the event you stumble, slip or fall.

Never shoot at a hard surface (rock, pavement, metal, ice, etc.) or at the surface of water, as the bullet may ricochet (glance off) the surface and travel in any direction, causing serious injury or death to someone you cannot see. Shoot only where there is a safe backstop (one which will safely stop and contain the fired bullets), free from rocks, hard objects and obstructions that could cause ricochets or splash-back of bullets, fragments, pebbles or rock particles. Check local and state laws to be sure shooting is permitted at the place you intend to shoot.

When shooting, be alert to be sure no one comes into the line of fire. Check the backstop and target area carefully to be sure it is free of people each time before you begin to fire.

When firing with a group of people, put a responsible person in charge to maintain safety, discipline and control to reduce the chance of accidents. On a firing range, be alert to the commands of the range officer, and follow them precisely and immediately.

Do not handle a firearm when anyone is forward of the firing position. Before anyone moves downrange to post or check targets or for any other purpose, all firearms should be unloaded, with safeties engaged and actions locked open, and placed safely on the bench where they should not be touched or handled until everyone returns from downrange.

Do not handle firearms when you are tired, cold or impaired physically or mentally, in any way.

Never fire your rifle near an animal, unless it is trained to accept the noise of gunfire. An animal's startled reaction to the sound of gunfire could injure it or could cause an accident.

Never continue to use your rifle if it is not functioning properly. Never force a jammed action, as the jammed cartridge may explode if the primer is crushed or pressed against any metal part of the rifle.

Use only appropriate accessories for your rifle. Be sure all accessories, including slings, ammunition carriers, sights and sight mounts, etc. are compatible with the firearm and do not interfere with its safe operation. If in doubt, contact Traditions. Traditions is not responsible for any damage or injury caused by the use of improper accessories, and mounting, attachment or use of improper accessories could void the warranty.

III. MUZZLELOADING 'MUSTS' **FOR MUZZLELOADING SUCCESS**

You must:

1. Read completely, fully understand and follow all instructions and warranty limitations in this booklet before attempting to shoot your new Traditions muzzleloader.
2. Always treat any firearm as if it is loaded and keep the muzzle pointed in a safe direction.
3. Always wear proper eye and ear protection when loading or firing any firearm.
4. Don't shoot until you are absolutely sure of your target and what is beyond it. Do not point your firearms at anything you do not intend to shoot. Be sure that all bystanders are safely positioned behind you and that they are aware that you are about to shoot. All bystanders must also wear eye and hearing protection when in the vicinity of anyone using a firearm.
5. Use only the proper grade of black powder or black powder substitutes such as Pyrodex® powder, Pyrodex® Pellets or Triple 7® powder & Triple 7® pellets in properly measured amounts. Be sure to reference the chart in this booklet for recommended loads. Reduce charges of Triple 7® powder by 15%. For example, if you were using 150 grains of Pyrodex® powder and began to use Triple 7® powder, you would only use 130 grains of Triple 7®. Always consult the directions from the powder manufacturer before handling and loading any type of powder.
6. Never use any amount of smokeless gun powder in your muzzleloader. Although also black in color, smokeless powder is a very different chemical composition and it will produce dangerous pressures resulting in serious injury or death to yourself, bystanders and it will destroy your firearm.
7. Never smoke or permit others to smoke in the presence of black powder, Pyrodex®, Triple 7® or any other black powder substitute. Take care to guard against all potential ignition sources.
8. Never take drugs and/or drink alcoholic beverages before and during shooting.
9. Be certain that the powder, patches and projectiles are properly sized and measured and are loaded in the proper sequence and that the projectile is firmly seated on top of the propellant. See Section XI & X for proper loading instructions.
10. Use only cotton or linen shooting patches when loading round lead balls. Do not use any type of plastic patches.
11. Never load powder into a gun directly from a can, powder horn or flask. Always use a separate calibrated powder measuring device. A remaining spark or ember in the barrel may cause an ignition of the powder and cause injury or death to you, bystanders and destroy your firearm.
12. A firearm's safety is a mechanical device which can fail. Always be mindful of where the safety lever is set and routinely verify its setting. Never solely rely on any rifle's safety. Always treat every gun as if it were loaded and ready to fire. Only cap or primer your muzzleloader when you are ready to fire. Uncap or unprime your muzzleloader when you are done shooting or hunting.
13. Always disable your muzzleloader by carefully removing the percussion cap, musket cap or 209 primer and unloading the barrel when immediate shooting is not planned.
14. Never cap your firearm until you are ready to fire. Never install a percussion cap, musket cap or primer on the nipple before the gun is loaded. When loaded, a bump or unintentional pressure could result in the discharge of the firearms resulting in a serious accident.
15. Always store the powder, gun and percussion caps, musket caps or primers in separate locked places. Always keep all firearms and ammunition components secured and separate away from children. Never store a loaded gun.
16. In the event of a misfire, assume the gun could fire at any moment. Keep gun pointed down range with the action closed. Wait at least one minute before recapping, repriming or removing the load from the barrel.

17. Never load a muzzleloading firearm indoors. Only load your firearm in a location where it is safe to shoot.
18. Be certain that anyone firing this muzzleloader understands and is willing to follow the instructions and precautions in this manual and the fundamentals of safe firearm handling.
19. Always make certain that the safety is in the "on" position and the hammer is in the "at rest" position when installing the primer.
20. A great way to understand more about all types of firearms is to take a Hunter's Safety course.

***Take time now to acquaint yourself with
your new Traditions Muzzleloader.
If you have any questions
regarding your muzzleloader
after reviewing this information,
please contact the
Traditions Customer Service Department
for assistance at 1-800-526-9556.***

IV. LIMITED LIFETIME MECHANICAL WARRANTY

Traditions will warrant this muzzleloading firearm (or parts in a kit to be built) to be free of mechanical defects in materials or craftsmanship for the life of the firearm while in the possession of the original owner except *wooden stocks*. Traditions will repair or replace, at its own option, product or parts which are returned at owner's expense to the Traditions Customer Service Department. A full explanation of the specific problem must accompany the returned item. Call 1-800-526-9556 to obtain a factory issued Return Merchandise Authorization number (RMA#).

Firearms packaged and shipped improperly are not covered under warranty if damage occurs.

This warranty shall remain in force unless any of the following are determined by the Traditions Customer Service Department:

1. Use of any propellant other than black powder, Pyrodex® or Triple 7®.
2. Use of any powder charge in excess of those recommended in this booklet.
3. Use of any plastic patching material with round balls.
4. Modification of internal parts as they were shipped from the factory.
5. A lack of proper maintenance and thorough cleaning is evident such as rust.
6. Customer abuse.

Shipping Address:

Traditions Performance Firearms

1375 Boston Post Rd. • P.O. Box 776

Old Saybrook, CT 06475-0776

Tel. 800-526-9556

Fax. 860-388-4657

Website: www.traditionsfirearms.com

E-mail: info@traditionsfirearms.com

*Business hours: M-Th. 8:00-5:00 EST

Fri. 8:00-12:30 EST

* Hours may vary during the summer months.

If you are unsure how to package your firearm for return, ask your service representative when obtaining your RMA#.

V. MAKE SURE THAT THE MUZZLELOADER IS UNLOADED BEFORE PROCEEDING.

To check if the muzzleloader is unloaded, remove the ramrod, unscrew the jag and re-attach at the opposite end of the jag. Place the ramrod down the barrel. The ramrod should sit 3/4" below the muzzle. You should also be able to hear a metallic sound of the brass jag hitting the face of the breech plug. If your ramrod extends beyond the muzzle or you do not hear a metallic sound you will need to disassemble the muzzleloader and remove the obstruction before proceeding. Refer to the Section VII & VIII. Ramrod should sit below muzzle and you will need to hear a metallic sound to check if barrel is unloaded.



BEFORE YOU USE YOUR MUZZLELOADER, CLEAN & LUBRICATE IT!

These are brief instructions on what to do before you use your muzzleloader for the first time. Please review the Disassembly instructions inside for the complete set of instructions. When you first remove the new muzzleloader from the box there will be some manufacturing oils and grease for shipping purposes. These residues need to be removed so that the muzzleloader will function properly.

WARNING:

Make sure the firearm is unloaded with the safety in the "on" position. Refer to Section VI for safety operation.

1. Remove ramrod from the thimbles.
2. Remove the drop breech by holding the action release button in (located on the left side of the receiver) and slide the assembly out the action. Note: If your rifle is scoped reverse steps 2 and 3. Press action release button in towards breech block. Lift out breech block with other hand while holding in button. Breech block totally out of receiver area.
3. Unscrew and remove breech plug by using the breech plug wrench supplied with the muzzleloader. Remove the barrel from the receiver by removing the two allen screws



in front of the trigger guard. Unscrew 2 allen screws above trigger guard to remove barrel from stock.

4. Apply a light coat of Tradition's EZ Clean™ solvent to a dry patch (or use Tradition's pre-soaked patches) and run up & down the bore. Follow up with a few dry patches to wipe dry out the barrel. Now, use Traditions Wonderlube pre-lubed patches to "season" the lands & grooves of the rifling before loading. This will allow for easier loading and cleaning throughout your shooting sessions.
5. Generously lubricate the threads of the breech plug with Tradition's Breech plug grease. Make sure not to get any grease blocking the ignition channel of the breech plug.
6. Now reassemble your firearm. Remember to install the breech block with the knurled tang to the right side and the slotted area of the breech block should line up with the release button on the left side of the receiver area.

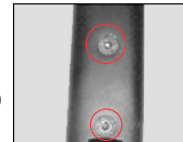

VI. SAFETIES INCLUDED WITH YOUR MUZZLELOADER

The Traditions muzzleloader uses two (2) types of safety mechanisms.

Use the safety on this rifle, but don't trust or rely on it as a substitute for safe gun handling practices. The safety is a mechanical device which could fail. Or, by mistake, you may think the safety is on when it is not. Or the safety may become disengaged without your knowledge. Or you could think your gun is unloaded when it is loaded. Always follow the safe gun handling rules and procedures in this manual, whether you think the safety is on or off, and whether you think the rifle is loaded or unloaded. Don't pull the trigger when the safety is engaged, or when it is positioned part way between Safe and Fire. Don't use or rely on the safety lever to try to "childproof" your rifle or keep it safe from untrained persons - instead, your rifle should be unloaded and securely locked up, out of access of children and other unauthorized users.

Use the safety on this rifle, but don't trust or rely on it as a substitute for safe gun handling practices. The safety is a mechanical device which could fail. Or, by mistake, you may think the safety is on when it is not. Or the safety may become disengaged without your knowledge. Or you could think your gun is unloaded when it is loaded. Always follow the safe gun handling rules and procedures in this manual, whether you think the safety is on or off, and whether you think the rifle is loaded or unloaded. Don't pull the trigger when the safety is engaged, or when it is positioned part way between Safe and Fire. Don't use or rely on the safety lever to try to "childproof" your rifle or keep it safe from untrained persons - instead, your rifle should be unloaded and securely locked up, out of access of children and other unauthorized users

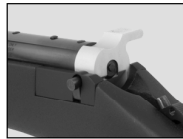

WARNING:

Check and inspect both safeties for proper function before each use and after each cleaning. If the hammer does not return to the "at rest" position, the gun must be returned to the factory for inspection and repair. Failure to follow this rule can result in an accidental discharge which may cause injury and/or death to the shooter or bystanders and damage to property.

CAUTION:

With the safety set in the "Fire" (F) position and with the hammer pulled back to the fully cocked position, the gun is now ready to fire. Never rely totally on the fire arms mechanical "safety" device. The word "Safety" describes a firearms trigger block mechanism.

This mechanical device is designed to place your firearm in a safer status. No Guarantee can be made that the firearm absolutely will not fire even if the safety is set on the "Safe" (S) position.

Like any mechanical device, a "Safety" can sometimes fail. It can be jarred or inadvertently manipulated into an unsafe condition. Never test the safety while your firearm is loaded or at any time while it is pointed in an unsafe direction.

A Note About Maintenance Procedures:

Proper maintenance and cleaning of your new muzzleloader will require you to remove the barrel from the receiver. You must clean the muzzleloader each time it is used. Please see the Disassembly and Cleaning sections for more information. Take time before such cleaning to study the Disassembly/Assembly procedures and the accompanying photographs to thoroughly acquaint yourself with your rifle's subassemblies.

VII. DISASSEMBLY:

Your muzzleloader is equipped to use a standard 209 shotgun primer for the ignition. The 209 primer area is built directly into the breech plug. Make sure that you remove the 209 breech plug and clean the threads of both the breech plug and inside of the barrel before ever firing your muzzleloader. You must lubricate the threads of the breech plug with Traditions breech plug grease before you install it back into the barrel. This will help prevent the breech plug from getting stuck inside the barrel after shooting.



1. Remove the ramrod and make sure the gun is unloaded. See Section V.
2. Remove the drop breech. See Section VI.
3. Unscrew the two screws in front of the trigger guard and remove the barrel from the stock. Note: If you have a scope mounted reverse steps 2 and 3.
4. Remove the screw behind the trigger guard and pull the entire trigger and hammer assembly down and out of the stock. Trigger guard & trigger can be removed by unscrewing the allen screw behind the trigger guard.



WARNING:

DO NOT ATTEMPT TO DISSASSEMBLE THE RECEIVER. THIS INCLUDES ANY PINS HOLDING THE RECEIVER TOGETHER. CLEAN AS A COMPLETE UNIT. IF YOU ATTEMPT TO DISSASSEMBLE ANY PART OF THE RECEIVER IT WILL AUTOMATICALLY VOID ANY WARRANTY ON THIS FIREARM AND CAN MAKE THE FIREARM UNSAFE FOR USE AND MAY CAUSE MAJOR INJURY OR DEATH.

VIII. IGNITION & BREECH PLUGS

Your muzzleloader is equipped to use a standard 209 shotgun primer for the ignition. The 209 primer area is built directly into the breech plug. Make sure that you remove the 209 breech plug and clean the threads of both the breech plug and inside of the barrel before ever firing your muzzleloader. You must lubricate the thread of the breech plug with Traditions breech plug grease before you install it back into the barrel. This will help prevent the breech plug from getting stuck inside the barrel after shooting.



Note: Breech plugs will wear out over time and should be replaced periodically. We recommend that you purchase at least one extra breech plug for emergencies in the field or at the range. We recommend that you replace your breech plugs after every year and nipples after every hunting season.

Removal of the Breech Plug:

1. Make sure the muzzleloader is unloaded and unprimed. Lower the drop breech action, cock the hammer to allow sufficient room for the wrench to attach to the breech plug and position the large open end of the breech plug wrench over the breech plug, taking care to fully seat the wrench over the breech plug. Make sure you fully seat the wrench over the breech plug.



2. Insert the rod handle into the hole in the wrench to form a T.
3. Turn the wrench counter-clockwise, unscrew the breech plug and remove from barrel. It may require some extra force to free up the breech plug after shooting.

TIPS FOR STUCK BREECH PLUGS:**IMPORTANT:**

Always make sure to lubricate the breech plug threads liberally with Traditions breech plug grease before using your muzzleloader.

- a. With the breech plug wrench fitted over the breech plug, actually try to tighten the plug and then rock it back and forth to loosen up the fouling.
- b. Remove the barrel from the receiver. Pour some hot water into the barrel and let it soak for about 1/2 hour. Secure the barrel in a padded vise. Position the wrench onto the breech plug and remove. Be careful not to scald yourself with the hot water.
- c. If you still cannot remove plug, contact Traditions Customer Service Department.

Installation of the Breech Plug:

1. Spray the breech plug inside and out with Traditions EZ Clean™ solvent or use the EZ Clean™ bath system to loosen the residue and fouling on the plug. Use a stiff brush to clean the outside threads and inner area of the breech plug. A pipe cleaner can be used to get the smaller areas clean and dry.
2. Wipe with a clean cotton cloth. Repeat until all residue is off.
3. Liberally apply Tradition's Breech Plug grease onto the threads of the breech plug.
4. Place the breech plug in the barrel.
5. Slide the wrench onto the plug and screw it in clockwise.
6. Snugly tighten the breech plug into the breech area. Do not over-tighten.

For reasons of safety and proper performance, these loading instructions for your Traditions muzzleloader must be followed closely. While some of the procedures may seem cumbersome, with practice they will soon become second nature and will make for safe, dependable and accurate shooting. (It is very helpful to have an experienced black powder shooter with you the first few times you load and shoot your muzzleloader.) If, after reading these instructions you still have questions concerning the safe use of your muzzleloader, contact Traditions Customer Service Department. 1-800-526-9556

IX. PREPARING TO LOAD & LOADING

MUZZLELOADING SHOTGUN

DANGER:

The use of SMOKELESS POWDER in any TRADITIONS muzzleloaders will result in excessively high pressures and will destroy the rifle and cause injury or death to the shooter and bystanders.

If you have any questions regarding powder velocities and pressures please contact the manufacturer of the propellant.

1. Black powder, Pyrodex™, Pyrodex™ pellets or Triple 7® powder & pellets are the only safe propellants to use in this muzzleloading rifle. Maximum charges of Triple 7® should be reduced by 15%. This means that the maximum amount of Triple 7® powder that can be used is 130 grains.
2. The term “black powder” does not refer to any powder black in color, since modern smokeless powders are also black in color.
3. Be certain that the propellant you select is commercially manufactured black powder, Pyrodex™ or Triple 7® are for use in muzzleloaders.

CAUTION:

Never smoke while loading, shooting or handling propellants. Always follow the manufacturer’s safety precautions as listed on the propellant container.

PREPARING TO LOAD THE PROPELLANT:

1. Wear eye protection.
2. Make certain the gun is unloaded.
 - a. Push safety button to “safe”.
 - b. Insert the ramrod into the barrel. When it is touching the top of the breech plug it should sit approximately 3/4" below the muzzle.

Note: You should hear a metallic sound as the brass jag makes contact with the breech plug.

If the ramrod is not 3/4" below the muzzle and you do not hear the metallic sound then the barrel may be either obstructed or loaded. To remove the obstruction, remove the breech plug and push the obstruction through with your ramrod. Do not attempt to clear the barrel by firing. Before loading anything into the barrel, clean all oil and grease from inside the barrel. We recommend using Traditions cleaning products to enhance your accuracy and ease shooting & cleaning.

To clear the ignition channel (with an un-obstructed barrel) follow these steps.

Point the rifle down towards a safe area on the ground and load a primer into nipple area of the breech plug. Fire off one or two primers to blow out any oil or residue from the fire channel. Point the muzzle at a leaf or blade of grass to see if it moves. If it moves, you have a clear channel. If not, fire additional primers or check the breech plug for obstructions. Remember to remove your ramrod before firing with this method.

Another way to see if you have a clear fire channel is to place a dry patch on the muzzle of your rifle. Using the ramrod with the loading/cleaning jag attached, push the patch down to the breech plug face and leave ramrod & patch in bore. Point the rifle in a safe direction, place primer in nipple area of the breech plug and fire off two primers(one at a time). Remove ramrod from the bore and inspect patch. Patch should have a complete circular burn in middle. This gives you visual evidence that you have a clear fire channel.

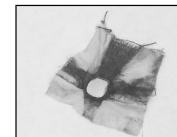

LOADING THE POWDER FOR MUZZLELOADING RIFLES:

Stand the butt of the rifle on the ground so that the muzzle is pointed up and away from you and others. Never work with your face or any part of your body over the muzzle, even when the gun is unloaded. Be sure that the firearm is unprimed and the safeties are engaged. Your rifle is now ready to be loaded.

Use only Black Powder, Pyrodex™ loose or pelletized powder or Triple 7® loose or pelletized powder. Follow the Powder Manufacturer's Instructions when handling any type of powder. Make sure to reduce your charge by 15% when using Triple 7 loose powder.

When loading loose powder:

- Fill your Traditions flask with powder.
- Adjust your Traditions powder measure to the desired charge. See Section XVI.
- Pour powder from your Traditions flask into the desired powder charge. Pour powder from the powder measure down the barrel.

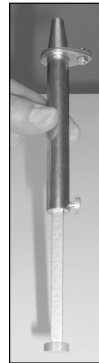
**WARNING:**

Never load powder into a gun directly from a can, powder horn or flask. Always use a separate calibrated powder measuring device. A remaining spark or ember in the barrel may cause injury or death to you, bystanders and destroy the firearm.

- Tap the side of the barrel to settle the powder into the breech area.

When loading pelletized powder (Pellets):

- Drop the desired amount of pellets into the barrel. Using a pipe cleaner to handle the pellets makes it easier to load and keeps oil from your hands off the pellet.

**IMPORTANT:**

Do not break or crush the pellets when loading or seating the projectile on top of the pellets. This could cause inconsistent groupings.

LOADING THE PROJECTILE:

Note: Your muzzleloader is equipped with the Projectile Alignment System (PAS), which helps ensure correct placement of the bullet in the muzzle.

Saboted Bullets: The plastic material used in our Traditions sabots is self-lubricating, therefore you need not pre-lube your bullets or sabots.

- Insert the base of the bullet into the sabot, making certain the bullet is firmly & fully seated against the bottom of the sabot.
- Place the assembled projectile into the muzzle.
- Start the projectile with your thumb.
- Using a ball starter, place the short shaft on top of the bullet and push it downward until the starter hits the top of the muzzle.
- Push the projectile deeper into the bore using the longer shaft of the ball starter until it hits the muzzle.
- With the loading jag on your ramrod, position the ramrod on top of the bullet inside the bore. Holding the ramrod no further than 6" over the bore apply firm pressure downward until the bullet is on top of the powder. (Holding the ramrod any higher will increase your chances of breaking your ramrod.)

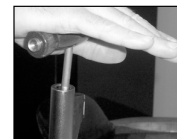
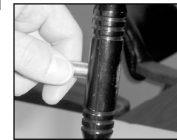
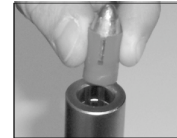
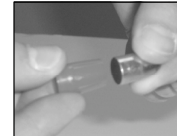

Note: If you are using pelletized powder do not crush them when loading the bullet. Testing has shown that crushed or broken pellets will cause bullet-grouping problems.

7. After the bullet is seated fully against the powder charge, mark the ramrod at the muzzle. You can use a pencil or knife to mark the rod. This will show you that each projectile is seated at the same depth each time. If you change the desired powder charge or projectile, you will need to change the mark and make a new one for the new charge.
8. Make sure you remove the ramrod out of the barrel before priming and shooting the muzzleloader.



IMPORTANT:

ALWAYS SEAT THE BULLET FIRMLY ON TOP OF THE POWDER CHARGE. FAILURE TO DO THIS MAY RESULT IN INJURY OR DEATH TO YOU AND/OR BYSTANDERS.

Note: When using conical bullets or patched round ball, it is recommended to use loose powder only.

CONICAL BULLETS:

1. Lubricate the projectile with Wonderlube 1000 Plus®.
2. Place the projectile into the barrel, using the ball starter and ramrod. Follow the same procedures as shown with the sabot bullet loading.

Note: Patches are not to be used with conical bullets, these bullets are made to full bore size.

It is critical that the conical bullet is the correct size to your bore. It must fit fairly tight and require moderate pressure to seat on top of the powder. A loose fit could cause the projectile to separate from the powder, particularly if the gun is subjected to jarring or sharp movement before ignition.

X. PRIMING YOUR MUZZLELOADER

WARNING:

NEVER PRIME YOUR FIREARM UNTIL YOU ARE READY TO FIRE!

The 209 shotgun primer is very popular because of its' features and benefits for superior ignition. The 209 shotgun primer is exactly as it is named, a shotgun primer, the same primer used in a shotgun shell. The 209 primer has three main benefits over the #11 cap and the musket cap. First, the 209 primer is water-resistant which keeps water and moisture out for a sure-fire ignition when conditions are damp or rainy. Second, the 209 primer is larger than the caps and can be handled easier with gloves when in hunting situations. Thirdly, they are 10 times hotter than a #11 percussion cap which gives a more reliable ignition. Your new rifle uses a 209 primer.

When capping your muzzleloader please follow these instructions: Only cap or prime your muzzleloader after you have loaded the rifle and you are ready to shoot.

1. Make sure that the manual safety on your muzzleloader is in the "safe" position.
2. Point the muzzleloader in a safe direction.
3. Keeping the muzzle pointed in a safe direction, open the action to expose the breech area. Using a 209 capper or your fingers, press the primer into the nipple opening in the breech plug. Close the gun. Make sure that the action is completely closed. When you are ready to fire the muzzleloader, place the safety in the "fire" position and cock the hammer.
4. Your muzzleloader is now ready to fire.

XI. DECAPPING YOUR MUZZLELOADER

AFTER FIRING:

1. Press action release button and open barrel to expose primer.
2. Using a de-priming tool or finger, remove the spent primer.

IF YOUR MUZZLELOADER FAILS TO FIRE:

Anyone involved with muzzleloading firearms may experience a hangfire or misfire. The following are a few simple procedures that will help you to effectively manage such occurrences.

XII. HANGFIRES & MISFIRES

Hangfire

A hangfire is a delayed ignition. The primer fires when the trigger is pulled and the main charge fires a brief moment later. There are many reasons that hangfires occur. If you are experiencing hangfires, there are possible causes that you need to evaluate. Verify the following:

1. Verify that the primer is the correct size and properly fitted onto the nipple.
2. Inspect that the ignition channel is clear of obstructions.
3. Verify that the proper propellant is being used and that it is the proper granulation and is free from moisture, contamination and oils.
4. Check the condition of the primers and propellant powder. For hunting situations, it is a wise practice to use fresh primers and powder. Use a fresh load for each day's hunting.

Misfire

A misfire is a failure of either the primer or the main charge to ignite. This could be a very hazardous situation. **Extreme caution should be exercised when dealing with a misfire.**

Rarely is a misfire the fault of the rifle. Generally, it can be attributed to a problem with the propellant or primer.

Should your gun fail to fire for any reason, **keep the muzzle pointed at your down-range target for at least one minute with the action closed.** By doing so, you make sure you are prepared for the chance of a delayed ignition.

If the percussion cap/primer did not fire:

1. Check to make certain that a primer was installed and is still securely positioned on nipple.
2. Verify that the striker face is free of debris.
3. Try a new primer.

If the primer fires but the main charge does not:

1. Remove the primer while keeping the barrel pointed in a safe direction. Using a cleaning pick, verify that the hole in the breech plug is clear of any obstruction.
2. Tap the butt pad of the rifle with your hand to direct the powder into the ignition channel. If you are using pellets this process will not help.
3. Verify that propellant was loaded under your projectile by running the ramrod down the muzzle and observing the measure marks on your ramrod. Use extreme caution to always keep the muzzle pointed in a safe direction.
4. Check for any mechanical defects in the breech area. If your gun has repeatedly failed to fire, you will need to unload the rifle. See Section XIV. At this point a beginning shooter should seek assistance from an experienced shooter. Never leave an unfired charge in the barrel.
5. After verifying the above directions reprime the muzzleloader and fire.

XII. REMOVING THE PROJECTILE AND THE CHARGE:

Method 1

1. Make sure the muzzle of the barrel is pointed in a safe direction at all times.
2. Open the action and carefully remove the primer from the breech plug.
3. Using the Breech Plug/Nipple wrench, supplied with the rifle, remove the breech plug from the rear of the barrel.
4. Insert a ramrod into the muzzle and push the load out of the rear of the barrel.
5. Clean and wipe all surfaces of loose fouling and debris.

NOTE: *It is also possible to drive the projectile out of the muzzle after the powder has been removed. However, an extra long bench rod or a standard ramrod with an extension will be needed to accommodate the added length of the receiver.*

Method 2

1. Open the gun and carefully remove the primer from the breech.
2. Using a range/bench ramrod, with a ball puller screw in one end, insert the screw end into the muzzle until the screw makes contact with the projectile.
3. Apply pressure to the end of the ramrod while at the same time turning it, allowing the ball puller screw to bite into the projectile.
4. Continue turning the ramrod until you can determine that the ball puller screw is well anchored into the projectile.
5. Firmly grasp the exposed end of the ramrod with projectile attached, pull it through the barrel and out of the muzzle. One continuous non-stop pull is generally best.

NOTE: *When extracting sabot bullets the first few inches of the pull will separate the projectile from the plastic sabot.*

At this point the bullet will be free from the sabot and will come out easily. It will then be necessary to reinsert the ball puller screw back down the barrel and screw it into the plastic sabot and also pull it out.

6. Remove powder, if any.
7. Clean and dry the bore of the barrel making sure the breech area is dry before reloading fresh powder.

XIV. SIGHTING IN AND SCOPE MOUNTING

SIGHTING IN:

Start your sighting in at approximately 25 yards with a large target. You want to achieve a grouping of shots no matter where on the target first. After you are able to shoot at least 3 shots in the same 2" area, then adjust your sight to the center bull's-eye.

To adjust: Move the rear sight in the direction you want the bullet to go.

Note: *Traditions recommends while sighting in your muzzleloader that you clean the bore between each of your shots. By doing this you are starting out with a fresh, seasoned bore that will help prevent some shooting errors such as powder build up that could cause poor inaccuracy. Different projectiles and recommended powder charges can vary in accuracy, so make sure to sight in using the same projectiles and powder charges first and then change if needed. Make sure to use the recommended charges.*

SCOPE MOUNTING:

Most Traditions muzzleloaders are drilled and tapped for mounting a scope. To sight in your scope, please follow the scope manufacturer's directions.

XV. RECOMMENDED RIFLE LOADS:

Traditions recommends that you begin your shooting with a charge between 80 grains of Black powder or Pyrodex loose or pelletized powder (use 56 grains of Triple 7 loose powder) to lessen the recoil & let yourself get acquainted with your muzzleloader. The bullet that you need is dependent upon the game you are hunting. Tradition's recommends using a powder charge of 80-150 grains depending on what you are hunting or shooting with your muzzleloader

The maximum powder load for the muzzleloaders when using Pyrodex® powder is 150 grains.

The maximum powder load for the muzzleloaders when using Triple 7® loose powder is 130 grains.

RECOMMENDED POWDER AND PROJECTILES

Every muzzleloader shoots differently. Finding the best load for your muzzleloader requires some experimenting with different powder and projectile combinations. Use the guide below to start, if you find that some other load works better in your gun, use it as long as it is within the recommended limits. This guide is only to be used as a reference and more information can be found in our product catalog or by calling our Customer Service line.

We recommend Traditions brand projectiles with all of our muzzleloaders because we have tested them thousands of times and have received the best accuracy, energy transfer and expansion with our APB (All Purpose Bullet) bullets. We have two styles of bullets that work excellent in all of our muzzleloaders; one is the APB100 which is a poly tipped bullet which is excellent for longer distance shooting because of the flat shooting trajectory and the other model is the APB200 which is our lead tipped bullet which will expand at short & long distances and uses a unique hydraulic system to transfer energy. Please see our Product catalog for more information.

.50 Caliber APB200 Lead Tip Bullets			
100 grains of Triple 7® pellets			
250 grain bullet	@ Muzzle	Velocity	Energy
		1871	1943
100 grains of Triple 7® pellets			
275 grain bullet	@ Muzzle	Velocity	Energy
		1764	1900
100 grains of Triple 7® pellets			
300 grain bullet	@ Muzzle	Velocity	Energy
		1698	1921
100 grains of Triple 7® pellets			

Traditions offers a wide variety of muzzleloading projectiles and sabots. Experimentation, within the recommended loading data, with different grain weight bullets and powder charges will allow you to maximize your accuracy with your muzzleloader. We offer less expensive projectiles to start out with so that you can get the feel of your muzzleloader first and then purchase the better performing bullets.

XVI. CLEANING & MAINTENANCE:

A systematic routine of cleaning while shooting is strongly advised to aid in avoiding problems while loading and to optimize accuracy.

1. When cleaning the bore, use Traditions EZ Clean™ cleaning patches rather than shooting patches. Shooting patches are too small for cleaning and can be lost in the bore.
2. If a patch becomes lost in the bore, use Traditions Patch Puller Worm attached to a ramrod for retrieval, or if necessary, remove the breech plug and push the patch out through the breech area. **Never load a charge over a lost patch.**

3. If unusual resistance is felt while loading a projectile, place a EZ Clean™ cleaning patch on a cleaning jag affixed to the end of a ramrod and run it the full length of the barrel several times with your objective being to remove as much of the fouling build up as possible. **Important: You will need to run some dry patches up and down the bore to dry it out before loading the gun again.**

NOTE: It should never be necessary to hammer or excessively force a projectile down the bore. Projectiles should load firmly against the powder charge with a series of short strokes. If the projectile is the proper size, unusual resistance usually indicates the need to swab the bore with a treated cleaning patch. Use EZ Clean™ solvent if barrel is heavily fouled. An occasional cleaning of the bore with a brass Traditions Bore Brush is advisable to remove excessive plastic and fouling build-up.

4. When target shooting or sighting in, develop a habit of consistently wiping the bore with Traditions Wonder Lube 1000 patches after each shot. Depending upon the specific load, temperature, and humidity, a short series of shots with black powder, Pyrodex® or Triple 7® can be fired before it becomes necessary to wipe the bore with Traditions EZ Clean™ patches or in order to remove fouling build-up.

If for any reason the projectile will not go all the way down to the powder charge, it will be necessary to extract the projectile from the barrel either with a bullet puller on a ramrod or the breech plug can be removed, the charge removed and the projectile forced out the end of the barrel with a long bench/range rod or an extended ramrod.

NOTE: A dirty fouled barrel will directly affect your ability to group shots. However, in a hunting situation, only a few shots will likely be taken. If the barrel is prepped and lubed at the onset, it is not necessary to clean and lube the interior of the barrel between shots when hunting.

CLEANING AFTER SHOOTING

CAUTION:

Before cleaning, make absolutely certain the gun is unprimed and unloaded. Use the ramrod measuring method as described earlier.

Clean your gun as soon as possible after your shooting session. To leave a gun uncleaned, even overnight, can result in serious and damaging corrosion.

ADVICE: Take care when cleaning not to get water or solvent into the trigger assembly.

NOTE: Regardless of the cleaning method, you must remove and thoroughly clean the the breech plug and area of the receiver during each cleaning. Be certain to lightly lubricate the threads of the breech plug with Traditions Breech plug grease before reinstalling.

Cleaning Method

A thorough cleaning requires the complete disassembly of the firearm every time you shoot your muzzleloader.

1. Make sure the firearm is unprimed and unloaded.
2. Remove the drop breech by holding the action release button in and slide the assembly out the top of the rifle. Clean the breech block with an EZ Clean™ soaked patch and then dry and lubricate with Wonderlube 1000 Plus®. Note: If your rifle is scoped reverse steps 2 and 3.
3. Remove the barrel from the receiver by removing the two allen screws in front of the trigger guard.
4. Remove the screw behind the trigger guard and take the trigger/hammer assembly out of the stock.
5. Using a Breech Plug Wrench, remove the breech plug from the barrel. Drop the breech plug into the Traditions EZ Clean™ Bath and let soak until you are finished cleaning your barrel and other parts of the muzzleloader. Use a pipe cleaner and dry cloth to clean in and out of the plug.

6. Pour 8-10 inches of hot water mixed with Traditions EZ Clean™ solvent concentrate (A1755) into a secured pail.
7. Immerse the receiver end of the barrel into the cleaning solution.
8. Using a cleaning patch affixed to a jag or a cleaning brush, pump the solution repetitively through the barrel by raising and lowering the ramrod until bore is clean.
9. When the bore is clean, remove barrel from liquid. Run dry cleaning patches up and down bore to dry inside. Wipe outside of barrel with dry cloth.
10. Clean receiver area with EZ Clean™ spray and a soft bristle brush to remove any fouling or debris. Dry receiver and breech area.

WARNING:

DO NOT ATTEMPT TO DISSASSEMBLE THE TRIGGER/HAMMER ASSEMBLY.

11. Lightly coat outside and inside of barrel and all other metal parts with Wonderlube 1000 Plus®. Apply Traditions breech plug grease to the threads of the breech plug.
12. Clean all residue from inside and outside of the stock.
13. Reassemble the muzzleloader.

TIP: When you are still using the muzzleloader during the hunting season you can clean the gun without removing the barrel from the stock. The above procedure is the most thorough type of cleaning and is recommended.

To clean the muzzleloader without removing the barrel.

1. Make sure the gun is unloaded and unprimed.
2. Remove the drop breech from the receiver.
3. Remove the drop breech by holding the action release button in and slide the assembly out the top of the rifle. Clean the breech block with an EZ Clean™ soaked patch and then dry and lubricate with Wonderlube 1000 Plus®.

4. Using a Breech Plug Wrench, remove the breech plug from the barrel. Drop the breech plug into the Traditions EZ Clean™ Bath and let soak until you are finished cleaning your barrel and other parts of the muzzleloader. Use a pipe cleaner and dry cloth to clean the inside and outside of the plug.
5. To clean the bore, use the convenient Traditions EZ Clean™ Foaming Bore Solvent. Pump the foam into the barrel until it comes out the other side. The solvent begins to work immediately. Run a few dry patches up and down the bore until they come out light grey or white. EZ Clean™ Foaming Bore solvent filled to top of barrel. A clean patch after cleaning with EZ Clean™ Foaming Bore solvent.
6. Lubricate the inside and outside of the bore with Wonderlube 1000 Plus patches.
7. Clean the breech plug threads inside the barrel by using a Traditions Breech brush (A3878). Clean receiver area with EZ Clean™ spray and a soft bristle brush to remove any fouling or debris. Dry receiver and breech area. Lightly oil the metal surfaces.
8. Add Traditions Breech Plug grease to the threads of the breech plug and re-install.
9. Make sure safeties and all functions of the muzzleloader work properly.

NOTE: Store your rifle in a cool, dry, secured area. Storage in a gun case should be avoided as it may hasten condensation and corrosion. During long periods of storage, periodically check for signs of pitting or rusting on the surface and in the barrel bore.

NOTE: The myth that stainless steel & nickel doesn't have to be cleaned as much as blued steel is false. You need to clean and lubricate your stainless barrel just as you would a blued steel barrel. The stainless and nickel barrels are more rust resistant than blued steel, but over time can rust.

XVII. HELPFUL MUZZLELOADING ACCESSORIES

In order to participate fully in the sport, you will probably want to consider the purchase of the various Traditions accessories mentioned in this manual. Your firearms retailer should stock a complete line of accessories from Traditions. If not, ask him to order them for you. Visit him soon to discover all the ways to make your muzzleloading experience even more enjoyable and convenient.

Write to Traditions for a current catalog showing a complete line of firearms, ammunition and accessories or view it on our web site www.traditionsfirearms.com.

Your local retailer can special order any Traditions products you want.

PREFERRED CUSTOMER WARRANTY REGISTRATION CARD

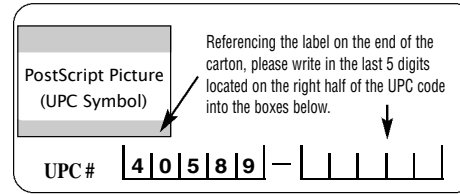

Model # _____
 Serial # (from barrel) _____
 Name _____ Age _____
 Street _____
 City _____ State _____ Zip _____
 Day Time Phone # _____ Date of Purchase _____
 Purchase Price _____ Store Name _____

1. What is your age? 1 Under 18 2 18-24 3 25-34 4 35-44 5 45-54 6 55-64 7 over 65
2. Reason for your purchase 1 Hunting 2 Target Shooting 3 Personal use 4 Gift 5 Raffle Prize 6 Other
3. Do you own? 1 Other muzzleloaders 2 Over/Under Shotgun 3 Side by Side Shotgun 4 Semi-Auto Shotgun 5 Pump Shotgun 6 Cartridge Rifle 7 Handgun 8 Bow
4. Where purchased? 1 Gun Shop 2 General Sporting Goods Store 3 Hardware Store 4 Chain Store 5 Mail Order Catalog 6 Internet Store
5. Is this your first muzzleloader? 1 Yes 2 No
6. Which factors influenced your purchase? 1 Previously owned a Traditions product 2 Magazine Ad/Article 3 Internet/Website 4 Traditions Catalog 5 Recommendation of Salesperson 6 Recommendation of a Friend 7 Price 8 Features 9 Other
7. What type of game do you hunt? 1 Whitetail Deer 2 Mule Deer 3 Elk 4 Bear 5 Antelope 6 Turkey 7 Small Game 8 Other
8. What do you think is the best way to get information about Hunting & Hunting products? 1 Magazine Ads 2 Internet/Website 3 Television Programs 4 Radio
- 9a. Which magazine do you read? _____
- b. Which TV hunting show do you watch? _____

- Check here to receive a free Traditions catalog showing muzzleloadings' largest selection of firearms and accessories or visit our website at www.traditionsfirearms.com
- To receive a Traditions Firearms Logo cap and catalog, send \$11.95 along with your warranty registration card.



NOTE: Return this card within 15 days of purchase in order to validate your limited lifetime warranty.

Please complete all information above and mail to:

Traditions™
PERFORMANCE FIREARMS
 P.O. Box 776 • Old Saybrook, CT 06475-0776
www.traditionsfirearms.com

FIT-47 / 6.15.06 – JB2

Cut Along Dotted Line